



SINCE 1957 WE PROFILE IDEAS

EXTRUSION AND WORKING OF PLASTIC MATERIALS
ESTRUSIONE E LAVORAZIONE MATERIE PLASTICHE



SOFT PROFILES

PROFILI MORBIDI



The semi-manufactured plastic products belong to generic and commercial category of profiles, that are used to different application. These artifacts may be subject to special working upon request, as bevel cut, drilling, milling or shearing. All VBN profiles are in compliance with International rule DIN 16941 "Thermoplastics extruded profiles".

VBN produces:

COATING SOFT PROFILES
PROTECTION SOFT PROFILES
LIGHTING SOFT PROFILES
FRAMES SOFT PROFILES
BUILDING SOFT PROFILES

La produzione di semilavorati termoplastici plastificati a sezione variabile come di seguito illustrata fa parte della categoria profili commerciali generici, impiegati in differenti e numerosi campi di applicazione. Questi manufatti possono essere completati con lavorazioni speciali su richiesta quali tagli inclinati, forature, fresature o tranciate. Tutti i profili VBN sono conformi alla normativa internazionale DIN 16941 "Thermoplastics extruded profiles".

VBN realizza:

PROFILI MORBIDI DI RIVESTIMENTO
PROFILI MORBIDI DI PROTEZIONE
PROFILI MORBIDI PER ILLUMINAZIONE
PROFILI MORBIDI PER SERRAMENTI
PROFILI MORBIDI PER EDILIZIA

* other materials available on request / altri materiali disponibili su richiesta - pag 32

* other materials available on request / altri materiali disponibili su richiesta - pag 32

* other materials available on request / altri materiali disponibili su richiesta - pag 32

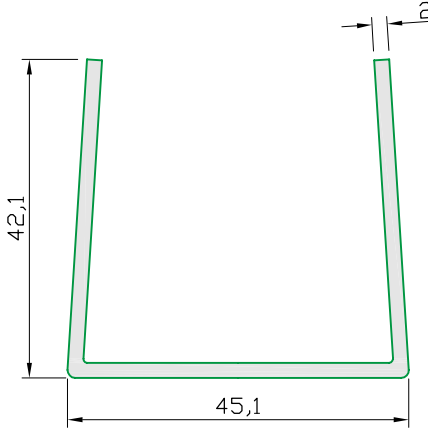
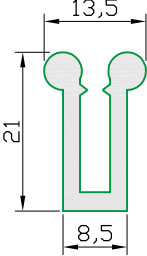
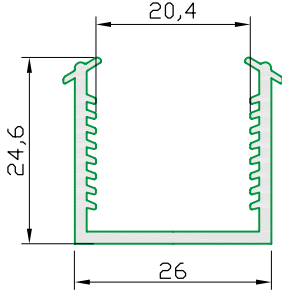
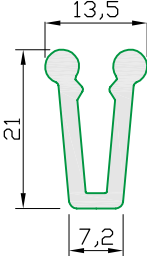
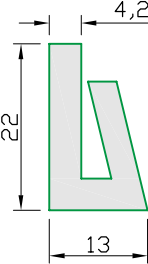
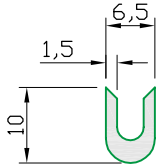
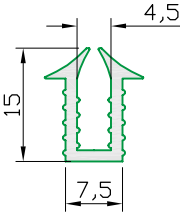
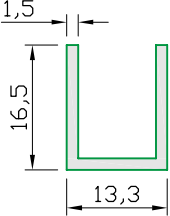
	CODE CODICE	PVC		CODE CODICE	PVC		CODE CODICE	PVC
	21	*		11	*		05	*
								
	09	*		12	*		10	*
								
	18	*		14	*		29	*
								

* other materials available on request / altri materiali disponibili su richiesta - pag 32

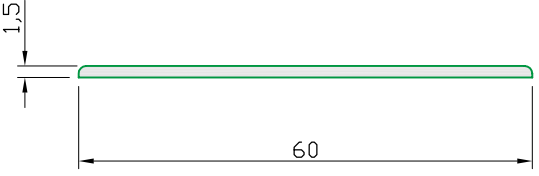
	CODE CODICE	PVC
	27	*
	25	*
	19	*

* other materials available on request / altri materiali disponibili su richiesta - pag 32

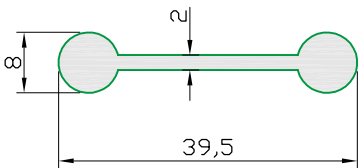
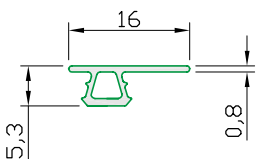
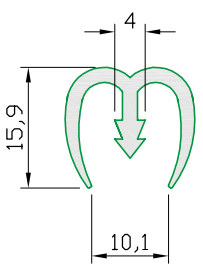
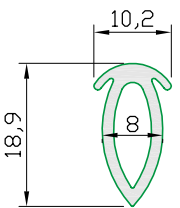
	CODE CODICE	PVC
	17	*
	06	*
	13	*
	15	*

* other materials available on request / altri materiali disponibili su richiesta - pag 32

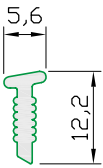
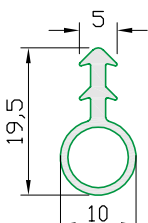
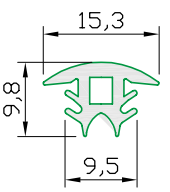
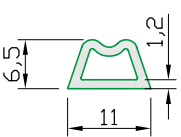
	CODE CODICE	PVC
	01	*
	33	*
	32	*
	23	*

* other materials available on request / altri materiali disponibili su richiesta - pag 32

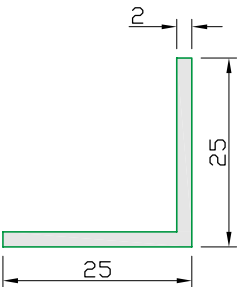
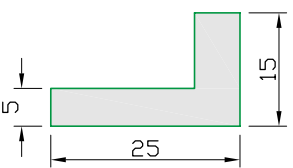
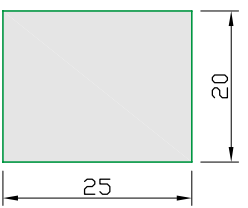
	CODE CODICE	PVC
	07	*
	06	*
	26	*

* other materials available on request / altri materiali disponibili su richiesta - pag 32

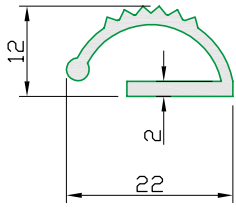
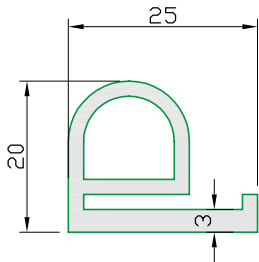
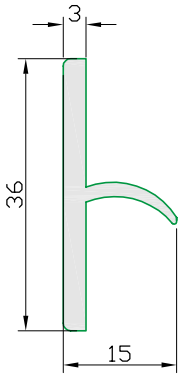
	CODE CODICE	PVC
	24	*
	20	*
	04	*

* other materials available on request / altri materiali disponibili su richiesta - pag 32

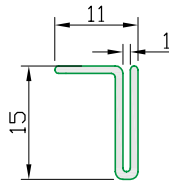
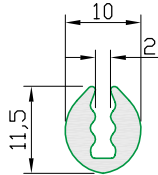
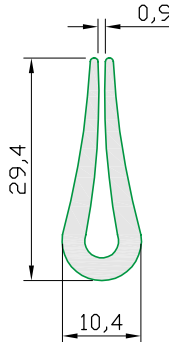
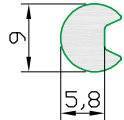
	CODE CODICE	PVC
	02	*
	22	*
	08	*
	16	*



VBN S.P.A.

VIA GALILEO GALILEI 45

31048 SAN BIAGIO DI CALLALTA (TV)

P.IVA 03404720264

T 0422 797285

F 0422 796196

INFO@VBNSPA.IT

vbnspa.it

